

MODCO-3-10x10

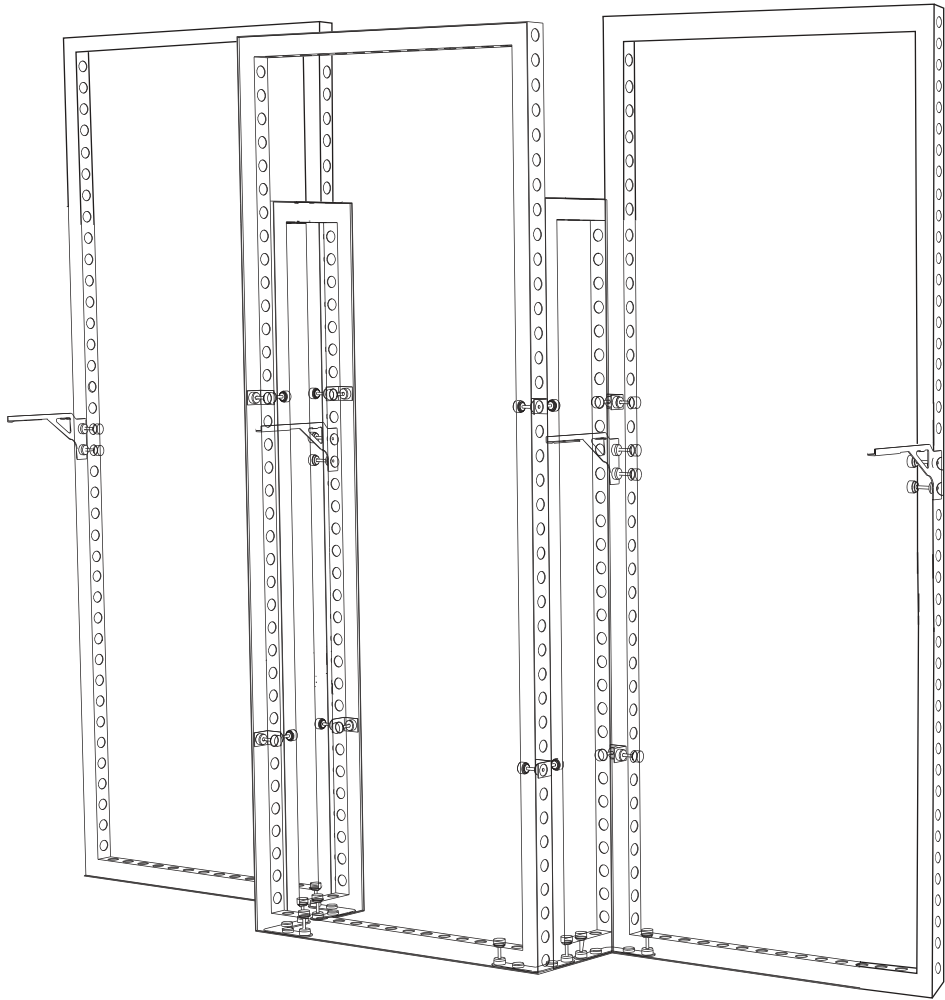

Instructions

Parts / Frames

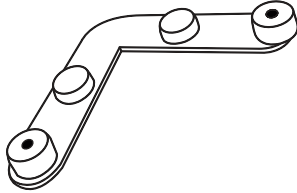

90° Connector
MOD-SM90D-CON
Qty.4

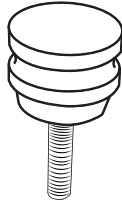

Pin Connector
MOD-PC
Qty.32

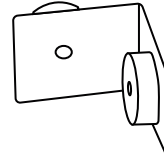

90° Connector
MOD-90D-CON
Qty.8

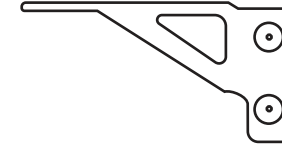

Shelf Holder
MOD-SHELF-KIT-INS
Qty.2



310 x 1984
MOD-FRM-310x1984
Qty.2



992 x 2418
MOD-FRM-992x2418
Qty.3



Counter Shelves
MOD-PNL
Qty.2

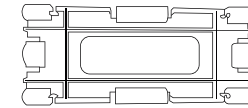

Clip Connector
MOD-CC
Qty.18



17" Cover Profile
MOD-CP-3100
Qty.2



78" Cover Profile
MOD-CP-3100
Qty.2



95" Cover Profile
MOD-CP-3100
Qty.4

Connections

C

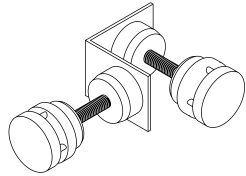

MOD-90D-CON + MOD-PC

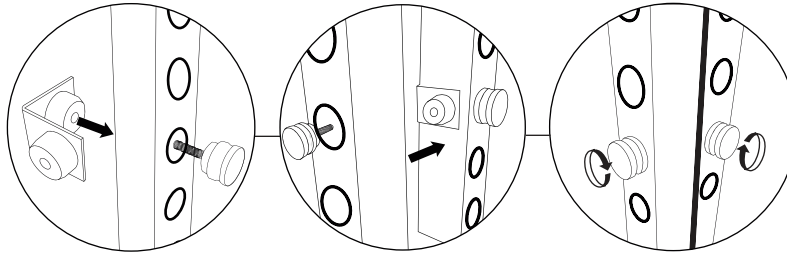

D

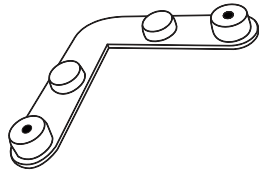

MOD-SM90D-CON / MOD-PC

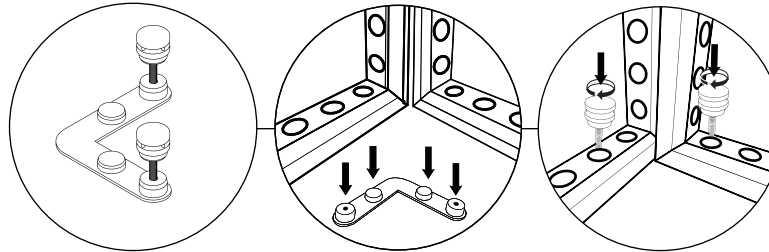

Cover Profiles

E

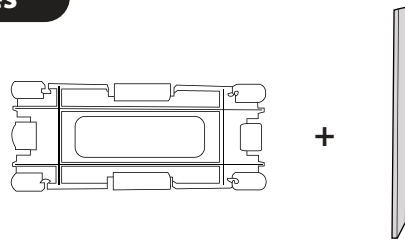

MOD-CC / MOD-CP-3100

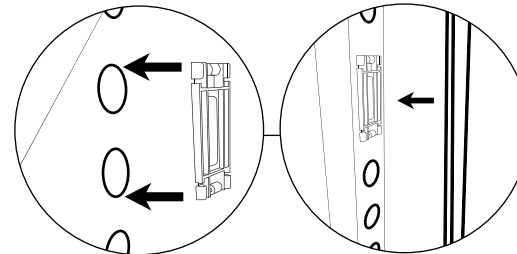

Shelves

F

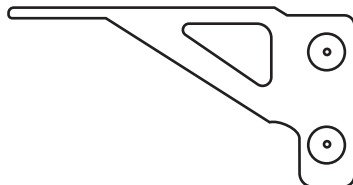

MOD-SHELF-KIT-INS

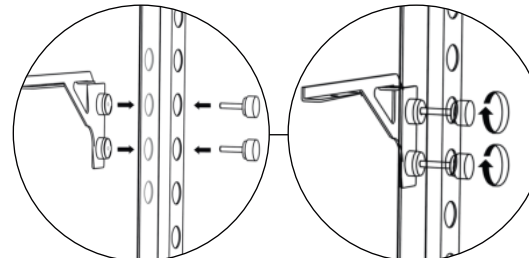

1

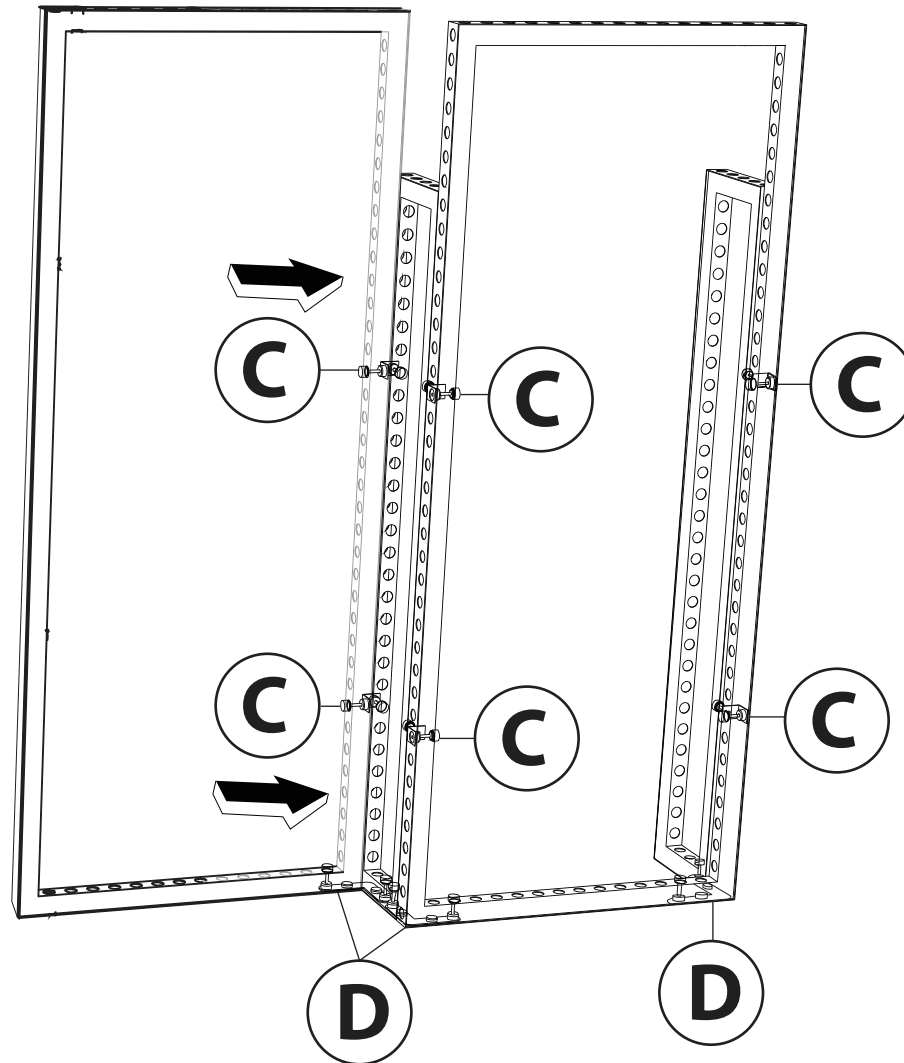

**Pre-install graphics on 310x1984 section before connecting.
(Graphic Install page)**

2

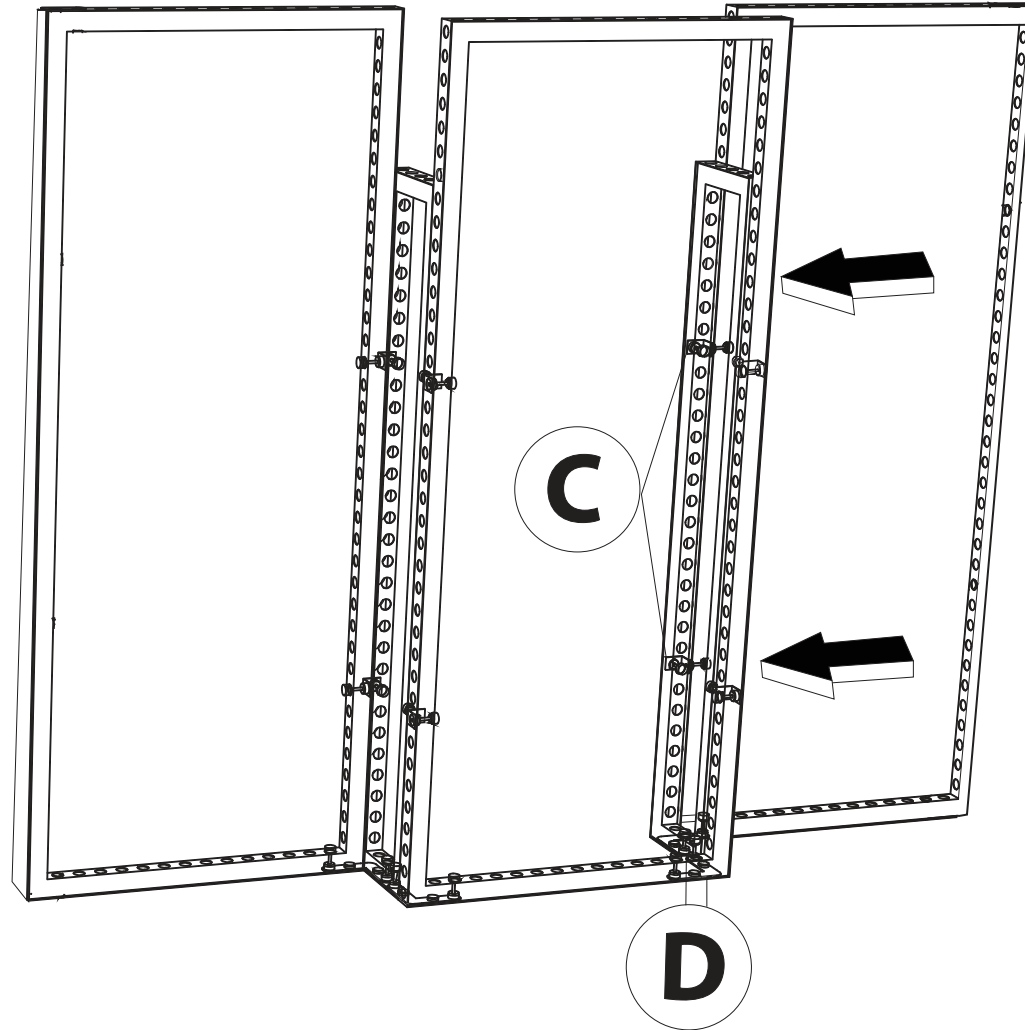

**Pre-install graphics on 310x1984 section before connecting.
(Graphic Install page)**

Graphic Install



Place graphic over the front of the frame.



Begin inserting SEG beading at each corner.

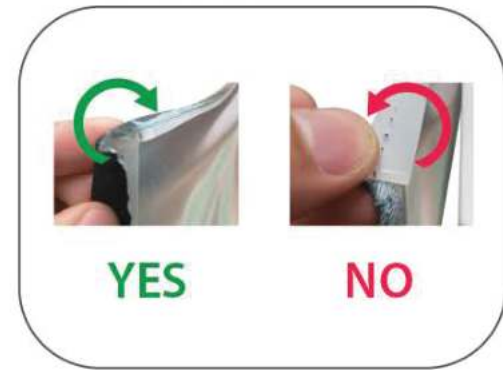

Insert the silicone beading with the fabric folded over. The silicone beading should not be exposed.

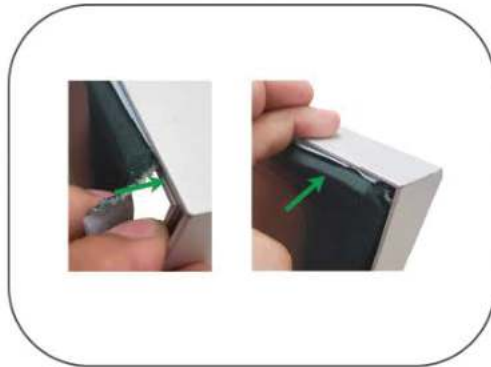

Using your fingers, push both fabric and silicone beading completely into the extrusions channel.



Continue to push in the remaining silicone beading on each side.



Check the perimeter of the frame for any excess beading that hasn't been pushed in. Graphic should be taut.

3

