

## Frame Assembly

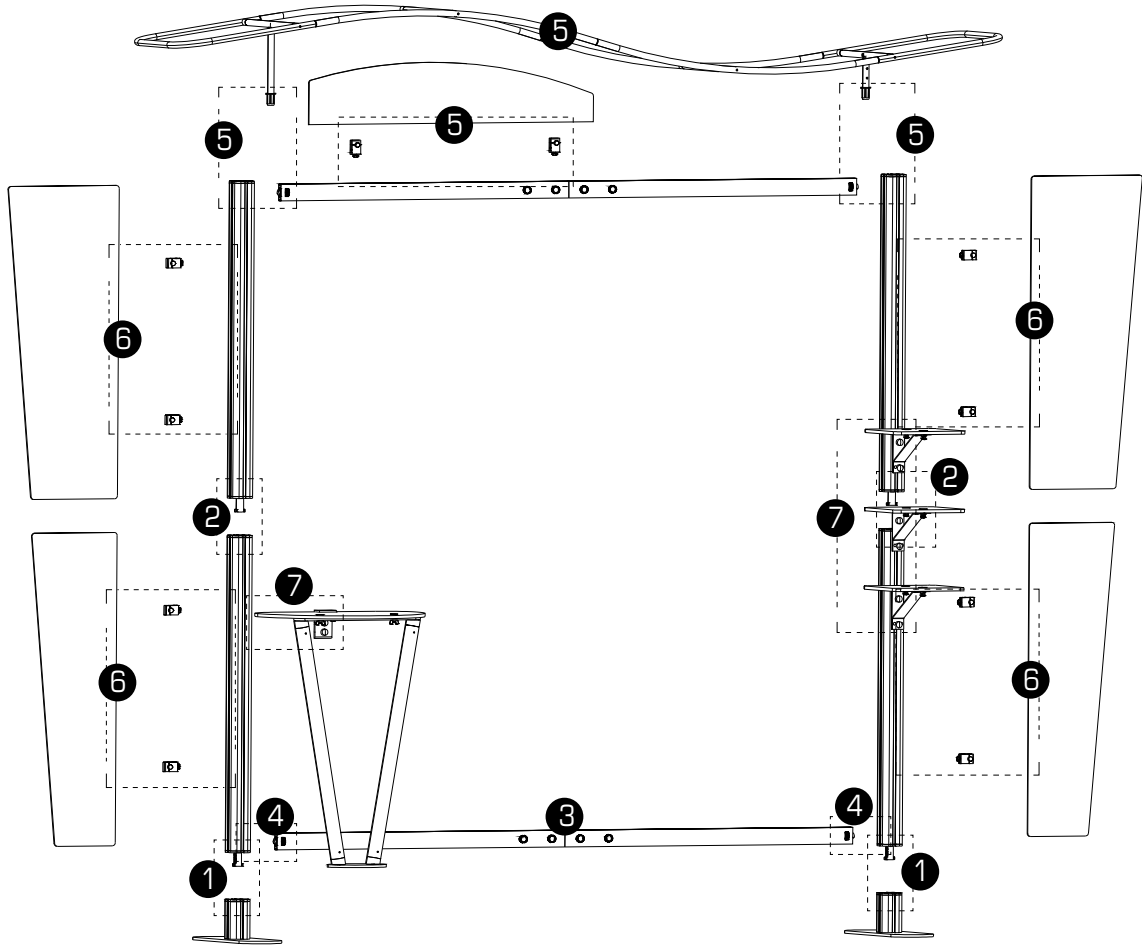

Key: Numbers [ # ] represents steps

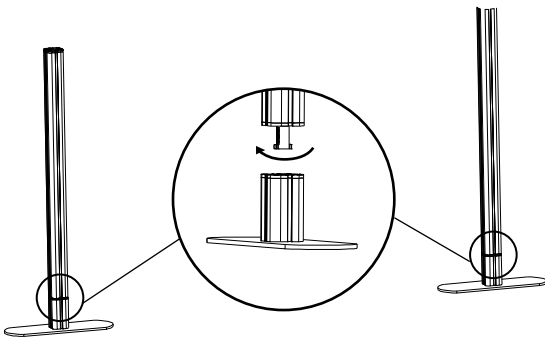

**STEP 1**

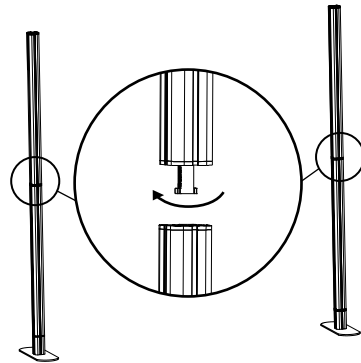

**STEP 2**

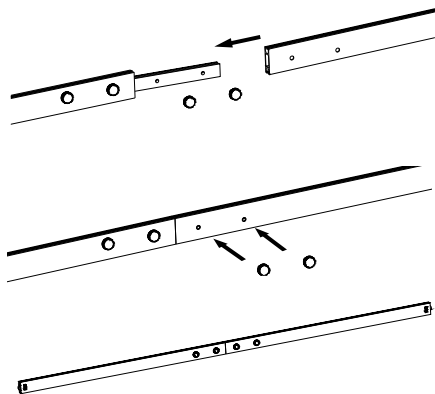

**STEP 3**

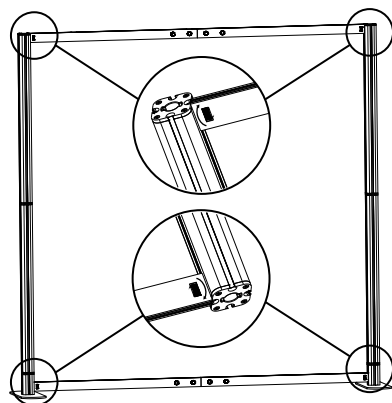

**STEP 4**

# 10 FT TAHOE TWISTLOCK INSTRUCTION

## Arch Frame

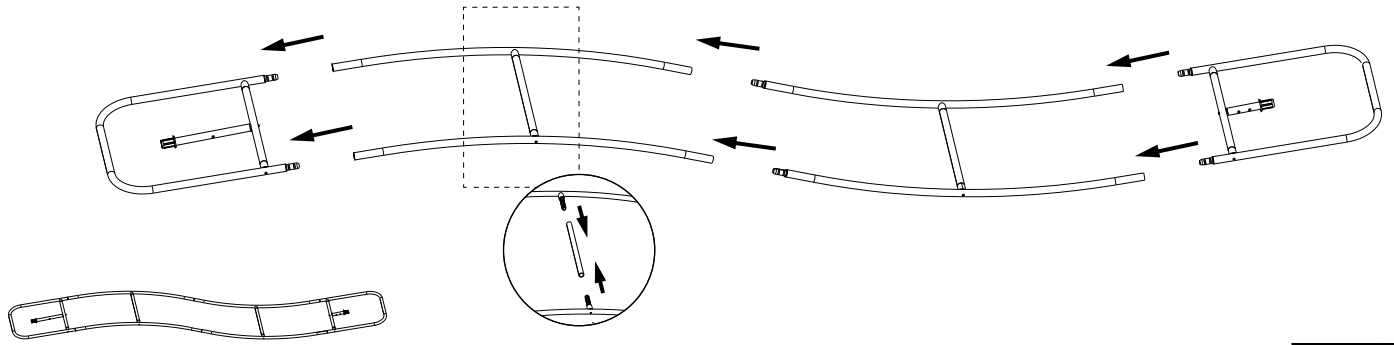

**STEP 5**

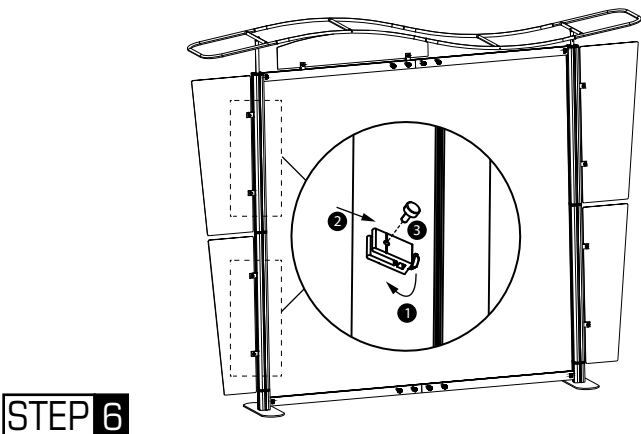
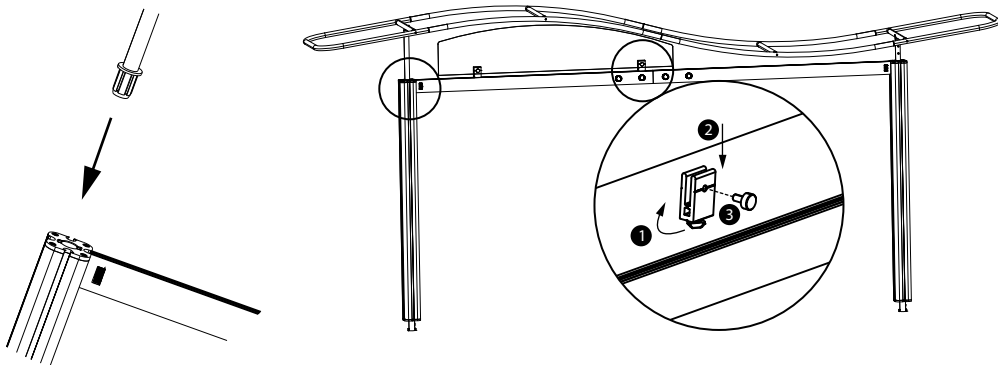

**STEP 6**

**STEP 7**

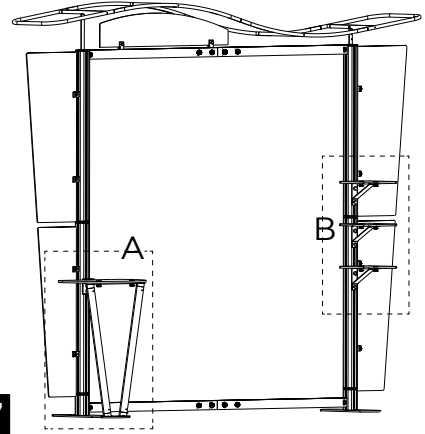

Completed Display

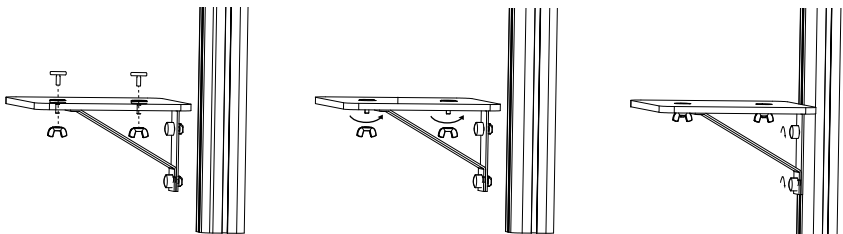

Table A

Table B

